

Automação

Comando e Sinalização - Linha CEW

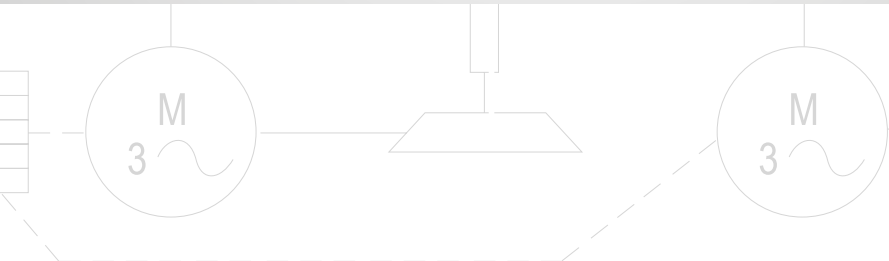

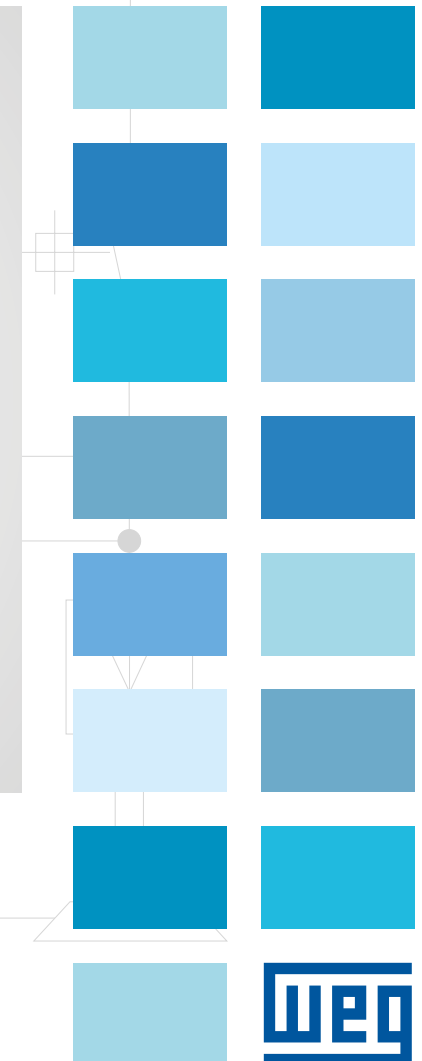
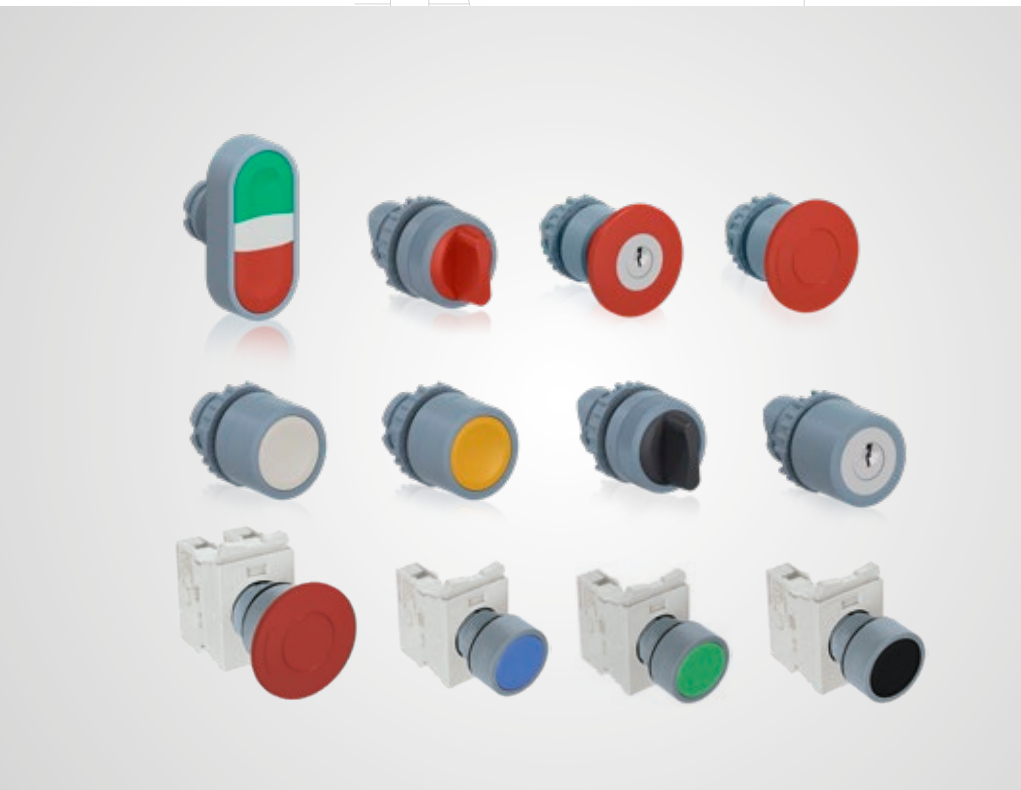
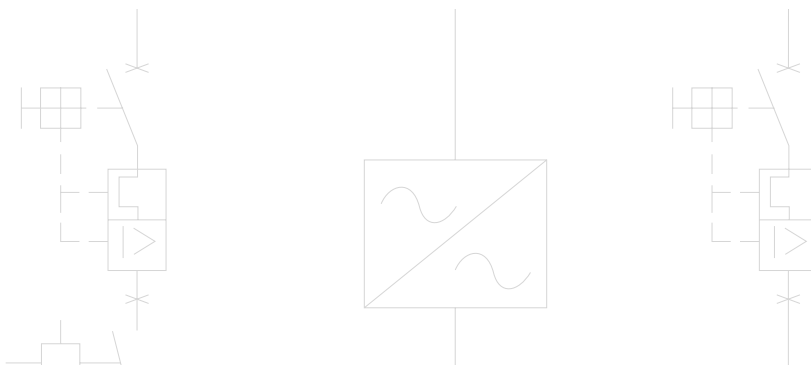

Comando e Sinalização - Linha CEW

Sumário

Apresentação	04
Botões Pulsadores - Não Iluminados - Ø22 mm	06
Botões com Trava - Não Iluminados - Ø22 mm	07
Botões Pulsadores - Iluminados - Ø22 mm	07
Sinaleiros Modulares - Ø22 mm - IP66	08
Comutadores de 2 Posições - Não Iluminados - Ø22 mm	08
Comutadores de 3 Posições - Não Iluminados - Ø22 mm	09
Comutadores - Iluminados - Ø22 mm	10
Acessórios - Montagem em Flange	12
Caixas de Montagem PBWL - IP54	13
Caixas de Montagem PBWL - IP66	13
Acessórios - Montagem em Base/Caixa	14
Acessórios Comuns com a Linha CSW	15
Sinaleiros Monobloco com LED (Ø22 mm)	16
Conjuntos Fornecidos (Ø22 mm)	17
Dados Técnicos	19
Dimensões (mm)	20

PRATICIDADE E SEGURANÇA PARA COMANDO E SINALIZAÇÃO



Projetada em conformidade com a norma IEC 60947-5-1, a linha de Comando e Sinalização CEW foi desenvolvida para aplicações gerais nos ambientes industriais. É uma **linha modular que apresenta um sistema de montagem rápida e fácil** com apenas um clique, dispensando a utilização de ferramentas.

A montagem dos blocos auxiliares é feita de forma sobreposta entre si, o que **permite um maior número de circuitos e redução de espaço no painel elétrico**. Os blocos auxiliares da linha, também são autolimpantes, garantindo melhor condutividade elétrica ao circuito mesmo em aplicações de baixo consumo de energia.

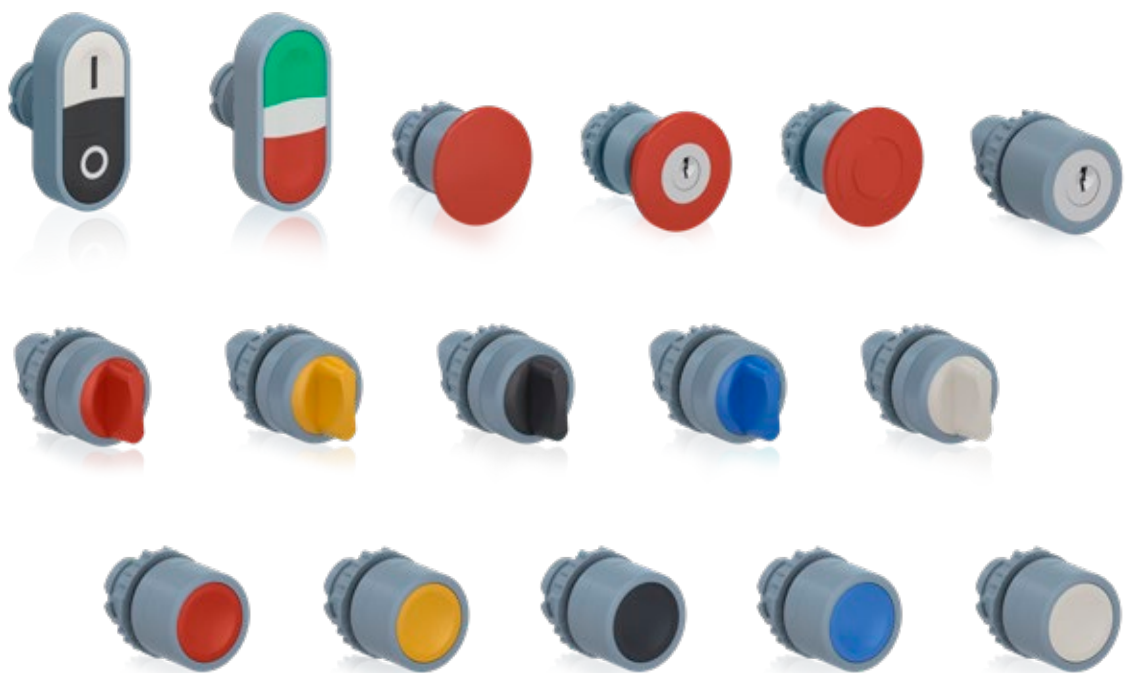

Botões Pulsadores - Não Iluminados - Ø22 mm

Fornecimento: Somente Frontal

Faceado

Foto ilustrativa	Cor	Referência	Código	Peso (kg)
		Branco	CEW-BFM0-WH	14363552
		Vermelho	CEW-BFM1-WH	14363551
		Verde	CEW-BFM2-WH	14363549
		Amarelo	CEW-BFM3-WH	14363553
		Azul	CEW-BFM4-WH	14363517
		Preto	CEW-BFM5-WH	14363550
				0,021

Cogumelo - Diâmetro Externo: Ø40 mm (Emergência)

Foto ilustrativa	Cor	Referência	Código	Peso (kg)
		Vermelho	CEW-BCM1-WH	14370967
				0,024

Como efetuar um pedido

- Frontal
- + Flange
- + Bloco de contato



Foto ilustrativa	Cor	Gravação	Referência	Código	Peso (kg)	
		Verde	I	CEW-BDM2110-WH	14406358	
		Vermelho	○			
		Verde	START	CEW-BDM21SS-WH	14406698	
		Vermelho	STOP			
		Verde	Sem gravação	CEW-BDM21-WH	14362978	
		Vermelho	Sem gravação			
		Branco	I	CEW-BDM0510-WH	14363514	
		Preto	○			
		Branco	START	CEW-BDM05SS-WH	14406700	
		Preto	STOP			
		Branco	Sem gravação	CEW-BDM05-WH	14406359	
		Preto	Sem gravação			
		Branco	+	CEW-BDM55PN-WH	14406702	
		Preto	-			
		Branco	↑	CEW-BDM55FR-WH	14406794	
		Preto	↓			
						0,030

Como efetuar um pedido

- Frontal
- + Flange
- + Bloco de contato



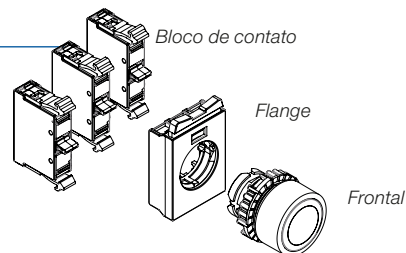
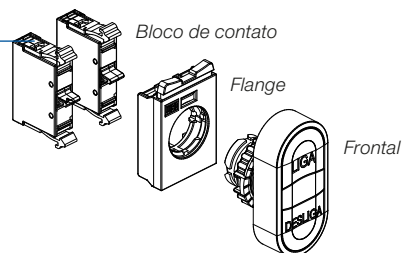

Botões com Trava - Não Iluminados - Ø22 mm

Fornecimento: Somente Frontal

Cogumelo Gira para Soltar - Diâmetro Externo: Ø40 mm

Foto ilustrativa	Cor		Referência	Código	Peso (kg)
		Vermelho	CEW-BCTM1-WH	14370966	0,027

Cogumelo com Chave - Diâmetro Externo: Ø40 mm (Emergência)

Foto ilustrativa	Cor		Referência	Código	Peso (kg)
		Vermelho	CEW-BCYM1-WH	14371118	0,090

Como efetuar um pedido

- Frontal
- + Flange
- + Bloco de contato

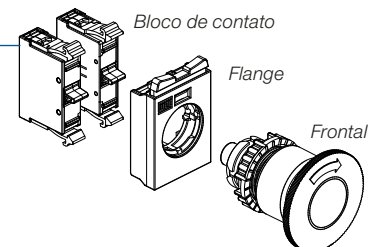

Botões Pulsadores - Iluminados - Ø22 mm

Fornecimento: Somente Frontal

Faceado

Foto ilustrativa	Cor		Referência	Código	Peso (kg)
		Branco	CEW-BFIM0-WH	14430263	0,021
		Vermelho	CEW-BFIM1-WH	14430264	
		Verde	CEW-BFIM2-WH	14430262	
		Amarelo	CEW-BFIM3-WH	14430265	
		Azul	CEW-BFIM4-WH	14430260	
		Laranja	CEW-BFIM6-WH	14430266	

Como efetuar um pedido

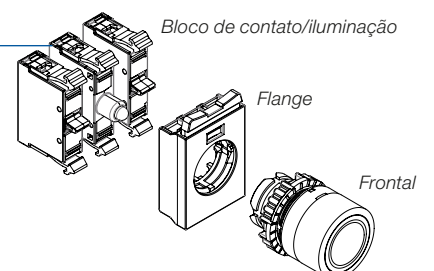

- Frontal
- + Flange
- + Bloco de contato
- + Bloco de iluminação



Sinaleiros Modulares - Ø22 mm

Fornecimento: Somente Frontal

Difusos

Foto ilustrativa	Cor		Referência	Código	Peso (kg)
		Branco	SINALEIRO CEW-SDM0-WH	14448451	0,016
		Vermelho	SINALEIRO CEW-SDM1-WH	14448453	
		Verde	SINALEIRO CEW-SDM2-WH	14448454	
		Amarelo	SINALEIRO CEW-SDM3-WH	14448455	
		Azul	SINALEIRO CEW-SDM4-WH	14448456	
		Laranja	SINALEIRO CEW-SDM6-WH	14449318	

Como efetuar um pedido



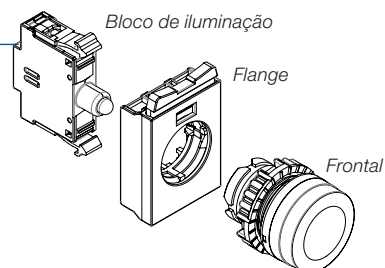







- Frontal
- + Flange
- + Bloco de iluminação













Comutadores de 2 Posições - Não Iluminados - Ø22 mm

Fornecimento: Somente Frontal

Knob Curto

Foto ilustrativa	Atuação		Diagrama	Ângulo do seletor	Cor		Referência	Código	Peso (kg)
		Fixa	1	45°		Cinza	CEW-CKM2F45-WH	14363627	0,025
		Retorno	1	45°		Cinza	CEW-CKM2R45-WH	14363681	
		Fixa	1	90°		Cinza	CEW-CKM2F90-WH	14363679	
			2	90°		Cinza	CEW-CKM2F90W-WH	14372371	
		Retorno	1	90°		Cinza	CEW-CKM2R90-WH	14363682	

Alavanca (Knob Longo)

Foto ilustrativa	Atuação		Diagrama	Ângulo do seletor	Cor		Referência	Código	Peso (kg)
		Fixa	1	45°		Cinza	CEW-CAM2F45-WH	14439592	0,025
		Retorno	1	45°		Cinza	CEW-CAM2R45-WH	14439596	
		Fixa	1	90°		Cinza	CEW-CAM2F90-WH	14439597	
			2	90°		Cinza	CEW-CAM2F90W-WH	14439619	
		Retorno	1	90°		Cinza	CEW-CAM2R90-WH	14439623	

Comutadores de 2 Posições - Não Iluminados - Ø22 mm

Com Chave











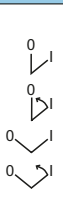

Foto ilustrativa	Atuação	Diagrama	Ângulo do seletor	Cor		Posição de retirada	Referência	Código	Peso (kg)	
		Fixa	1	45°	●	Cinza	Todas	CEW-CYM2F45-WH	14371119	0,087
		Retorno	1	45°	●	Cinza	Todas	CEW-CYM2R45-WH	14371120	
		Fixa	1	90°	●	Cinza	Todas	CEW-CYM2F90-WH	14371124	
			2	90°	●	Cinza	Todas	CEW-CYM2F90W-WH	14372372	
		Retorno	1	90°	●	Cinza	Todas	CEW-CYM2R90-WH	14371126	
		Fixa	1	45°	●	Cinza	Todas	CEW-CYME2F45-WH	14371159	
		Fixa	1	90°	●	Cinza	Todas	CEW-CYMD2F90-WH	14371164	
		Fixa	1	90°	●	Cinza	Todas	CEW-CYME2F90-WH	14371167	

Diagrama 1				Diagrama 2				Flange
Posição do comutador	Posição do contato na flange			Posição do comutador	Posição do contato na flange			
	2	3	1		2	3	1	
								3P
○	□	-	□	○	■	-	□	
I	■	-	■	I	□	-	■	

Legenda

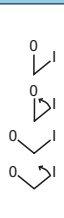
- Contatos em repouso.
- Contatos comutados.



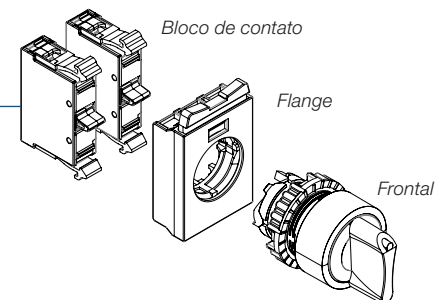



Como efetuar um pedido

- Frontal
- + Flange
- + Bloco de contato





Comutadores de 3 Posições - Não Iluminados - Ø22 mm

Fornecimento: Somente Frontal

Knob Curto

Foto ilustrativa	Atuação	Diagrama	Ângulo do seletor	Cor		Referência	Código	Peso (kg)	
		Fixa	1	45°	●	Cinza	CEW-CKM3F45-WH	14363683	0,025
		Retorno	1	45°	●	Cinza	CEW-CKM3R45-WH	14363684	
		Retorno à direita	1	45°	●	Cinza	CEW-CKM3RD45-WH	14363687	
		Retorno à esquerda	1	45°	●	Cinza	CEW-CKM3RE45-WH	14363685	

Alavanca (Knob Longo)

Foto ilustrativa	Atuação	Diagrama	Ângulo do seletor	Cor		Referência	Código	Peso (kg)	
		Fixa	1	45°	●	Cinza	CEW-CAM3F45-WH	14439625	0,025
		Retorno	1	45°	●	Cinza	CEW-CAM3R45-WH	14439626	
		Retorno à direita	1	45°	●	Cinza	CEW-CAM3RD45-WH	14439627	
		Retorno à esquerda	1	45°	●	Cinza	CEW-CAM3RE45-WH	14439668	

Comutadores de 3 Posições - Não Iluminados - Ø22 mm

Com Chave

Foto ilustrativa	Atuação	Diagrama	Ângulo do seletor	Cor		Posição de retirada	Referência	Código	Peso (kg)	
		Fixa	1	45°	●	Cinza	Todas	CEW-CYM3F45-WH	14371122	0,087
		Retorno	1	45°	●	Cinza	Todas	CEW-CYM3R45-WH	14371123	
		Retorno à direita	1	45°	●	Cinza	Todas	CEW-CYM3RD45-WH	14371158	
		Retorno à esquerda	1	45°	●	Cinza	Todas	CEW-CYM3RE45-WH	14371127	
		Fixa	1	45°	●	Cinza	Esquerda	CEW-CYME3F45-WH	14371161	
		Fixa	1	45°	●	Cinza	Direita	CEW-CYMD3F45-WH	14371162	
		Fixa	1	45°	●	Cinza	Centro	CEW-CYMC3F45-WH	14371163	
		Retorno à direita	1	45°	●	Cinza	Centro	CEW-CYMC3RD45-WH	14371188	
		Retorno à esquerda	1	45°	●	Cinza	Esquerda	CEW-CYME3RD45-WH	14371190	

Diagrama 1				Flange
Posição do comutador	Posição do contato na flange			
		2	3	1
	■	-	□	
	□	-	□	
	□	-	■	

Legenda

- Contatos em repouso.
- Contatos comutados.

Como efetuar um pedido

- Frontal
- + Flange
- + Bloco de contato

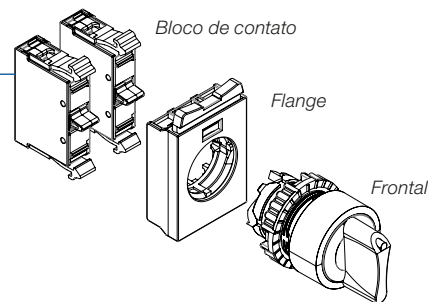

Comutadores - Iluminados - Ø22 mm





























Fornecimento: Somente Frontal

Knob Curto - 2 Posições















Foto ilustrativa	Atuação	Diagrama	Ângulo do seletor	Cor		Referência	Código	Peso (kg)	
		Fixa	1	90°	○	Branco	CEW-CKIM2F900-WH	14430267	0,020
					●	Vermelho	CEW-CKIM2F901-WH	14430288	
					●	Verde	CEW-CKIM2F902-WH	14430289	
					●	Amarelo	CEW-CKIM2F903-WH	14430290	
					●	Azul	CEW-CKIM2F904-WH	14430291	
					●	Laranja	CEW-CKIM2F906-WH	14430292	

Comutadores - Iluminados - Ø22 mm

Fornecimento: Somente Frontal Knob Curto - 3 Posições

Foto ilustrativa	Atuação	Diagrama	Ângulo do seletor	Cor	Referência	Código	Peso (kg)
		Fixa	2	45°	 Branco	CEW-CKIM3F450-WH	14430294
					 Vermelho	CEW-CKIM3F451-WH	14430295
					 Verde	CEW-CKIM3F452-WH	14430297
					 Amarelo	CEW-CKIM3F453-WH	14430348
					 Azul	CEW-CKIM3F454-WH	14430350
					 Laranja	CEW-CKIM3F456-WH	14430351
		Retorno	2	45°	 Branco	CEW-CKIM3R450-WH	14430352
					 Vermelho	CEW-CKIM3R451-WH	14430354
					 Verde	CEW-CKIM3R452-WH	14430356
					 Amarelo	CEW-CKIM3R453-WH	14430357
					 Azul	CEW-CKIM3R454-WH	14430388
					 Laranja	CEW-CKIM3R456-WH	14430389
		Retorno à direita	2	45°	 Branco	CEW-CKIM3RD450-WH	14430390
					 Vermelho	CEW-CKIM3RD451-WH	14430391
					 Verde	CEW-CKIM3RD452-WH	14430392
					 Amarelo	CEW-CKIM3RD453-WH	14430393
					 Azul	CEW-CKIM3RD454-WH	14430395
					 Laranja	CEW-CKIM3RD456-WH	14430396
		Retorno à esquerda	2	45°	 Branco	CEW-CKIM3RE450-WH	14430397
					 Vermelho	CEW-CKIM3RE451-WH	14430399
 Verde					CEW-CKIM3RE452-WH	14430400	
 Amarelo					CEW-CKIM3RE453-WH	14430402	
 Azul					CEW-CKIM3RE454-WH	14430403	
 Laranja					CEW-CKIM3RE456-WH	14430404	

0,020

Diagrama 1				Diagrama 2				Flange		
	Posição do comutador	Posição do contato na flange				Posição do comutador	Posição do contato na flange			
		2	3	1			2	3	1	
						I				3P
	I					II				

Legenda

- Contatos em repouso.
- Contatos comutados.
-  Posição de instalação dos blocos de iluminação nos comutadores iluminados.

Como efetuar um pedido

- Frontal
- + Flange
- + Bloco de contato
- + Bloco de iluminação

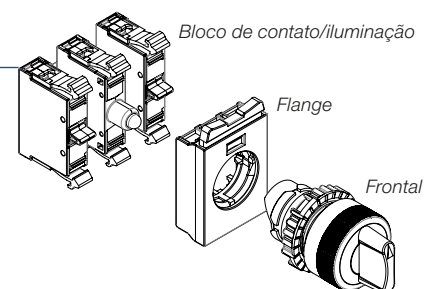



Acessórios - Montagem em Flange



























Flange Avulsa

Foto ilustrativa	Descrição	Embalagem	Referência	Código	Peso (kg)
	Flange de montagem 3 posições para blocos. Sistema de montagem <i>front-back</i>	10 peças	AFM3 X10	14362186	0,010

Blocos de Contatos

Foto ilustrativa	Contatos	Diagrama	Embalagem	Referência	Código	Peso (kg)
	1NA		10 peças	BCE10F-CEW X10	14362178	0,015
	1NF		10 peças	BCE01F-CEW X10	14362184	





Blocos de Iluminação com LEDs¹²

Foto ilustrativa	Códigos de tensão	Cor	Diagrama	Embalagem	Flange	Referência	Código	Peso (kg)
	12 V ca/cc	 Incolor		10	AFM3	CEW-BIDLEF-0E25	14428553	0,016
		 Vermelho		10		CEW-BIDLEF-1E25	14428556	
		 Verde		10		CEW-BIDLEF-2E25	14428557	
		 Amarelo		10		CEW-BIDLEF-3E25	14428578	
		 Azul		10		CEW-BIDLEF-4E25	14428579	
	24 V ca/cc	 Incolor		10		CEW-BIDLEF-0E26	14428580	
		 Vermelho		10		CEW-BIDLEF-1E26	14428581	
		 Verde		10		CEW-BIDLEF-2E26	14428582	
		 Amarelo		10		CEW-BIDLEF-3E26	14428563	
		 Azul		10		CEW-BIDLEF-4E26	14428564	
	48 V ca/cc	 Incolor		10		CEW-BIDLEF-0E27	14428565	
		 Vermelho		10		CEW-BIDLEF-1E27	14428567	
		 Verde		10		CEW-BIDLEF-2E27	14428609	
		 Amarelo		10		CEW-BIDLEF-3E27	14428610	
		 Azul		10		CEW-BIDLEF-4E27	14428611	
	110-130 V ca/cc	 Incolor		10		CEW-BIDLEF-0E10	14428612	
		 Vermelho		10		CEW-BIDLEF-1E10	14428613	
		 Verde		10		CEW-BIDLEF-2E10	14428615	
		 Amarelo		10		CEW-BIDLEF-3E10	14428616	
		 Azul		10		CEW-BIDLEF-4E10	14428617	
	220-240 V ca	 Incolor		10		CEW-BIDLEF-0D66	14428619	
		 Vermelho		10		CEW-BIDLEF-1D66	14428620	
		 Verde		10		CEW-BIDLEF-2D66	14428621	
		 Amarelo		10		CEW-BIDLEF-3D66	14428622	
 Azul		10	CEW-BIDLEF-4D66	14428623				

Notas: 1) Não compatível com as caixas plásticas PBWL.
2) Não permite montagem sobreposta.

Caixas de Montagem PBWL - IP54





Caixas Plásticas Vazias - Furação Ø22 mm¹⁾

Foto ilustrativa	Número de furos	Cor		Embalagem	Grau de proteção	Referência	Código	Peso (kg)
		Tampa	Base					
	1	Amarelo	Preta	1 peça	IP54	PBWL-1Y-IP54	14485064	0,114
	1	Cinza	Preta	1 peça	IP54	PBWL-1-IP54	14485006	0,114
	2	Cinza	Preta	1 peça	IP54	PBWL-2-IP54	14485007	0,152
	3	Cinza	Preta	1 peça	IP54	PBWL-3-IP54	14485058	0,185
	4	Cinza	Preta	1 peça	IP54	PBWL-4-IP54	14485061	0,215
	6	Cinza	Preta	1 peça	IP54	PBWL-6-IP54	14485063	0,276

Nota: 1) As caixas PBWL-IP54 são compatíveis com todos os modelos de frontais da linha CEW. Não permite montagem de botões cogumelos lado a lado com outros frontais, para esta montagem não utilizar o furo ao lado do botão cogumelo usando o acessório tampão ATR. Para a correta montagem dos frontais nas caixas PBWL não é necessário a utilização da flange de montagem.

Caixas de Montagem PBWL - IP66



Caixas Plásticas Vazias - Furação Ø22 mm¹⁾

Foto ilustrativa	Número de furos	Cor		Embalagem	Grau de proteção	Referência	Código	Peso (kg)
		Tampa	Base					
	1	Amarelo	Preta	1 peça	IP66	PBWL-1Y-IP66	14485002	0,114
	1	Cinza	Preta	1 peça	IP66	PBWL-1-IP66	14484926	0,114
	2	Cinza	Preta	1 peça	IP66	PBWL-2-IP66	14484998	0,152
	3	Cinza	Preta	1 peça	IP66	PBWL-3-IP66	14484999	0,185
	4	Cinza	Preta	1 peça	IP66	PBWL-4-IP66	14485000	0,215
	6	Cinza	Preta	1 peça	IP66	PBWL-6-IP66	14485001	0,276

Nota: 1) As caixas PBWL-IP66 são compatíveis com todos os modelos de frontais da linha CEW mas não garantem o grau de proteção IP66 pois a linha CEW tem grau de proteção IP54. Para os botões faceados (BFM) e botão duplo (BDM) utilizando a capa de proteção de silicone (APBF e APBD) pode-se garantir o grau de proteção IP66. Não permite montagem de botões cogumelos lado a lado com outros frontais, para esta montagem não utilizar o furo ao lado do botão cogumelo usando o acessório tampão ATR. Para a correta montagem dos frontais nas caixas PBWL não é necessário a utilização da flange de montagem.



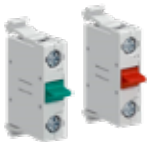























Acessórios - Montagem em Base/Caixa

Blocos de Contatos

Foto ilustrativa	Contatos	Diagrama	Embalagem	Referência	Código	Peso (kg)
	1NA		10 peças	BCE10B-CEW X10	14428801	0,015
	1NF		10 peças	BCE01B-CEW X10	14362184	

Nota: 1) Blocos específicos para montagem em base ou caixas plásticas PBW ou trilho DIN 35 mm.

Blocos de Iluminação com LED Integrado

Foto ilustrativa	Códigos de tensão	Cor	Diagrama	Embalagem	Flange	Referência	Código	Peso (kg)
	12 V ca/cc	 Incolor		10	PBWL	CEW-BIDLEB-0E25	14429491	0,016
		 Vermelho		10		CEW-BIDLEB-1E25	14429493	
		 Verde		10		CEW-BIDLEB-2E25	14429495	
		 Amarelo		10		CEW-BIDLEB-3E25	14429497	
		 Azul		10		CEW-BIDLEB-4E25	14429678	
	24 V ca/cc	 Incolor		10		CEW-BIDLEB-0E26	14429679	
		 Vermelho		10		CEW-BIDLEB-1E26	14429680	
		 Verde		10		CEW-BIDLEB-2E26	14429681	
		 Amarelo		10		CEW-BIDLEB-3E26	14429683	
		 Azul		10		CEW-BIDLEB-4E26	14429684	
	48 V ca/cc	 Incolor		10		CEW-BIDLEB-0E27	14429686	
		 Vermelho		10		CEW-BIDLEB-1E27	14429687	
		 Verde		10		CEW-BIDLEB-2E27	14429708	
		 Amarelo		10		CEW-BIDLEB-3E27	14429709	
		 Azul		10		CEW-BIDLEB-4E27	14429712	
	110-130 V ca/cc	 Incolor		10		CEW-BIDLEB-0E10	14429713	
		 Vermelho		10		CEW-BIDLEB-1E10	14429714	
		 Verde		10		CEW-BIDLEB-2E10	14429715	
		 Amarelo		10		CEW-BIDLEB-3E10	14429716	
		 Azul		10		CEW-BIDLEB-4E10	14429717	
	220-240 V ca	 Incolor		10		CEW-BIDLEB-0D66	14429768	
		 Vermelho		10		CEW-BIDLEB-1D66	14429769	
		 Verde		10		CEW-BIDLEB-2D66	14429772	
		 Amarelo		10		CEW-BIDLEB-3D66	14429789	
 Azul		10	CEW-BIDLEB-4D66	14429790				

Nota: 1) Blocos específicos para montagem em base ou caixas PBW ou trilho DIN 35 mm.

Como efetuar um pedido

- Frontal sem flange
- + Caixa plástica vazia
- + Blocos de contato ou de iluminação

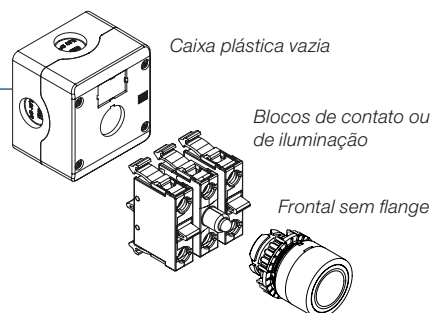

Acessórios Comuns com a Linha CSW



Tampão Redondo

Foto ilustrativa	Descrição	Embalagem padrão	Referência	Código	Peso (kg)
	Tampão redondo para fechar furos de Ø22 mm sem uso	5 peças	ATR	10185878	0,010

Chave Fixadora

Foto ilustrativa	Descrição	Embalagem padrão	Referência	Código	Peso (kg)
	Chave fixadora do anel de fixação da linha CSW/CEW	1 peça	CAF22	13218642	0,017

Capa de Silicone¹⁾

Foto ilustrativa	Descrição	Embalagem padrão	Referência	Código	Peso (kg)
	Capa de proteção adicional para botões duplos CEW-BFM (IP54) para garantir IP66	5 Peças	APBD	10046217	-
	Capa de proteção adicional para botões faceados CEW-BDM (IP54) para garantir IP67	5 Peças	APBF	10185879	-

Nota: 1) Capa de proteção adicional utilizada em aplicações especiais (panificação, construção civil, indústria alimentícia, etc.) usada para aumentar o grau de proteção de IP54 para IP66.



Sinais Monobloco com LED (Ø22 mm)

Tabela de Seleção

Referência	Tensão	Cor	Código WEG
CEW-SM1-E25	12 V ca/V cc	Vermelho	10046535
CEW-SM2-E25		Verde	10046536
CEW-SM3-E25		Amarelo	10046537
CEW-SM4-E25		Azul	10046538
CEW-SM0-E25		Branco	10046539
CEW-SM1-E26	24 V ca/V cc	Vermelho	10046540
CEW-SM2-E26		Verde	10046541
CEW-SM3-E26		Amarelo	10046542
CEW-SM4-E26		Azul	10046543
CEW-SM0-E26		Branco	10046544
CEW-SM1-C40	110-130 V cc	Vermelho	10046545
CEW-SM2-C40		Verde	10046546
CEW-SM3-C40		Amarelo	10046547
CEW-SM4-C40		Azul	10046548
CEW-SM0-C40		Branco	10046549
CEW-SM1-D13	110 V ca	Vermelho	10046525
CEW-SM2-D13		Verde	10046526
CEW-SM3-D13		Amarelo	10046527
CEW-SM4-D13		Azul	10046528
CEW-SM0-D13		Branco	10046529
CEW-SM1-D23	220 V ca	Vermelho	10046530
CEW-SM2-D23		Verde	10046531
CEW-SM3-D23		Amarelo	10046532
CEW-SM4-D23		Azul	10046533
CEW-SM0-D23		Branco	10046534



Composição da Referência

CEW-SM - - - -

Códigos de cores		
0	○	Branco
1	●	Vermelho
2	●	Verde
3	●	Amarelo
4	●	Azul

Códigos de tensão	
E25	12 V ca/cc
E26	24 V ca/cc
C40	110-130 V cc
D13	110 V ca
D23	220 V ca

Características Técnicas

Norma	IEC 60947-5-1
Grau de proteção (IEC 60529)	IP54
Consumo	15...20 mA
Temperatura	25 °C
Vida útil	30.000h
Brilho	≥60 mcd
Frequência (V ca)	50/60 Hz
Certificação	CE

Esquema de Conexão



Dimensional (mm)

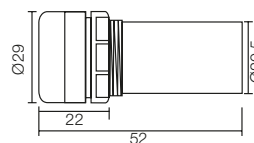

Observação: não recomendável o uso deste produto em circuitos elétricos com elevados níveis de distorção harmônica.

Conjuntos Fornecidos (Ø22 mm)

Botões Faceados

Botão Verde (1NA)



CEW-BFM2-1000000

Botão Preto (1NA)



CEW-BFM5-1000000

Botão Azul (1NA)



CEW-BFM4-10000000

Botão Vermelho (1NF)



CEW-BFM1-0100000

Botão Azul (1NF)



CEW-BFM4-01000000

Botão de Emergência

Gira para Soltar (1NF)



CEW-BEGM-0100000

Gira para Soltar (2NF)



CEW-BEGM-02000000

Gira para Soltar (1NA + 1NF)



CEW-BEGM-11000000

Botão Duplo

Liga-Desliga Sem Iluminação (1NA + 1NF)



CEW-BDM-1100000

Liga-Desliga com Gravação Sem Iluminação (1NA + 1NF)



CEW-BDM05IO-11000000

Comutadores Não Iluminados

**KNOB
2 Posições Fixas 45°
Liga-Desliga (1NA)**



CEW-CKM2F45-1000000

**KNOB
3 Posições Fixas 45°
Liga-Desliga-Liga (2NA)**



CEW-CKM3F45-2000000

**KNOB
3 Posições Fixas com
Retorno a Esquerda 45° (2NA)**

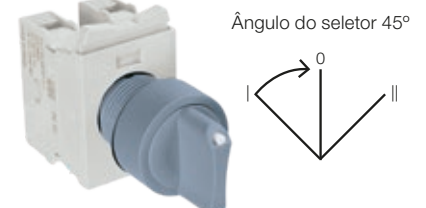

CEW-CKM3RE45-20000000

Conjuntos Fornecidos (Ø22 mm)

Comutadores Não Iluminados

KNOB 3 Posições com Retorno a 45° (2NA)

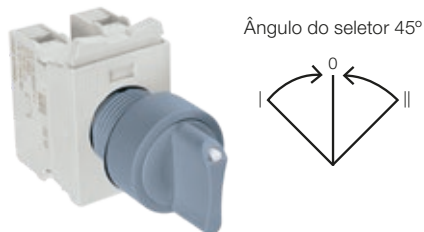

CEW-CKM3R45-20000000

KNOB 3 Posições com Retorno a 45° (1NA + 1NF)

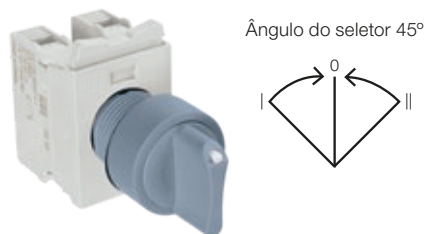

CEW-CKM3R45-11000000

Tabela de Seleção

Referência	Cor	Código WEG
CEW-BFM2-1000000	Verde	10047400
CEW-BFM5-1000000	Preto	10047399
CEW-BFM4-10000000	Azul	12076820
CEW-BFM4-01000000		11801688
CEW-BFM1-0100000	Vermelho	10047401
CEW-BEGM-0100000	Vermelho	10047403
CEW-BEGM-02000000		11025207
CEW-BEGM-11000000		11584595
CEW-BDM-1100000	Verde/Vermelho	10047402
CEW-BDM05I0-11000000	Branco/Preto	13334748
CEW-CKM2F45-1000000	Cinza	10047404
CEW-CKM3F45-20000000		10047405
CEW-CKM3RE45-20000000		14182217
CEW-CKM3R45-20000000		12642430
CEW-CKM3R45-11000000		12631243

Dimensional (mm)

BFM

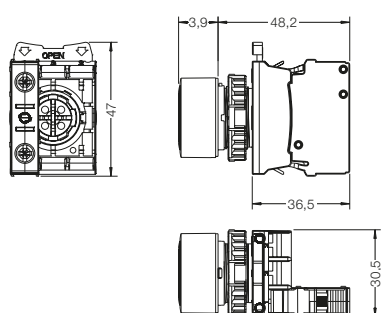

BDM

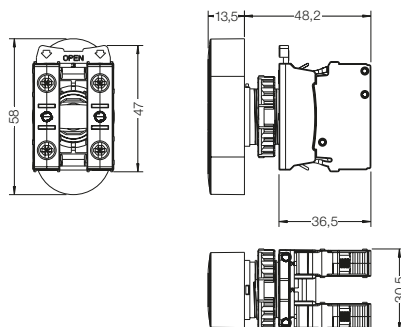

BEGM

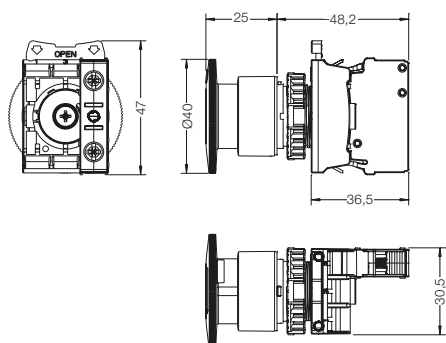

CKM

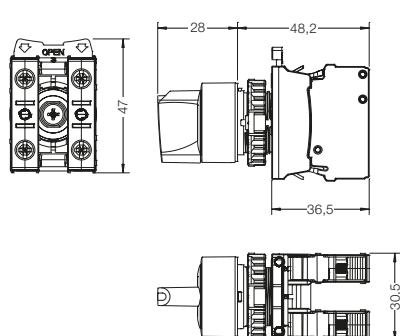

Dados Técnicos

Botões, Comutadores e Sinais

Normas aplicáveis	IEC 60947-5-1
Certificações	-
Grau de proteção	IP54
Materiais dos frontais	Poliamida (PA66) ou Policarbonato (PC)
Vida mecânica	
Botões CEW-BFM	3 x 10 ⁶ operações
Botões CEW-BDM	2 x 10 ⁶ operações
Botões CEW-BCTM/BCYM	3 x 10 ⁵ operações
Comutadores	1 x 10 ⁶ operações
Uso em ambientes	Externo ou interno
Faixa de temperatura de emprego	5 °C ... 40 °C

Caixas Plásticas Vazias PBWL

Normas aplicáveis	IEC 60947-5-1, IEC 50102, IEC 60529
Certificações	CE
Grau de proteção (IEC 60529)	IP54 / IP66
Faixa de temperatura de emprego	-25 °C...+70 °C
Material	ABS
Cor da tampa	Cinza (RAL 7035) ou amarelo (RAL 1003)
Cor da base	Preto (RAL 9005)
Entradas de prensa cabos	ØM20 / PG13,5 / 1/2" e ØM16 / 3/8"
Uso em ambientes	Externo (raios UV) ou interno

Blocos de Contatos

Normas aplicáveis	IEC 60947-5-1, ISO 13850 (EN 418), IEC 60947-5-5
Certificações	-
Tensão nominal de isolamento U _i	690 V
Tensão nominal de impulso U _{imp}	4 kV
Grau de proteção (IEC 60529)	IP20
Corrente térmica convencional I _{th}	10 A
Desempenho elétrico conforme	IEC 60947-5-1
Resistência dos contatos (IEC 60255)	≤25m Ω
Proteção contra choque elétrico (IEC 61140)	Classe II
Seção dos condutores (fio/cabo com ou sem terminal)	Mínimo (1 x 0,5 mm ²) e máximo (2 x 2,5 mm ²)
Torque de aperto	0,8 N.m
Faixa de temperatura de emprego	-25 °C...+70 °C
Resistência a choque mecânico	Sem danos ou desmontagem 100 g (1/2 senoide 11ms, de acordo com a MIL 202 B método 202 A)
Resistência a vibração (IEC 60068-2-6)	16 g para uma faixa de frequência de 40 a 500 Hz. Deslocamento máximo 0,75 mm (pico a pico)
Vida mecânica dos blocos de contatos BCE10F / BCE01F / BCE10B / BCE01B	1 x 10 ⁶ operações

Blocos de Iluminação com LED Integrado BIDL

Normas aplicáveis	IEC 60947-5-1
Faixa de tensão para operação	0,85...1,10 x U _e
Grau de proteção (IEC 60529)	IP20
Consumo (V ca/ V cc)	10 mA
Tensão nominal de impulso U _i (IEC 60947-1)	2,5 kV
Faixa de temperatura de operação	- 25 °C...+70 °C
Vida útil média	100.000 horas
Brilho	Vermelho 70 mcd
	Amarelo 115 mcd
	Branco 275 mcd
	Azul 64 mcd
	Verde 150 mcd
Seção dos condutores (fio / cabo com ou sem terminal)	Mínimo (1 x 0,5 mm ²) e máximo (2 x 2,5 mm ²)
Torque de aperto	0,8 N.m

Dimensões (mm)

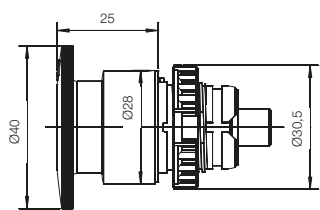

BCTM

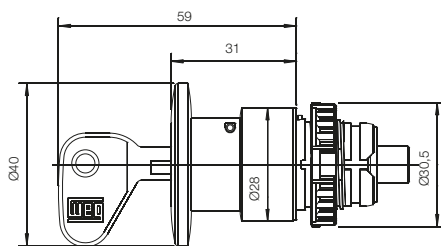

BCYM

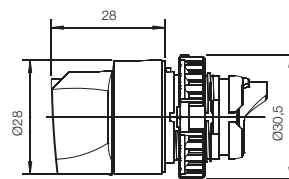

CKM

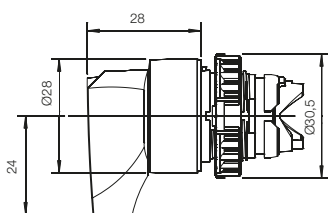

CAM

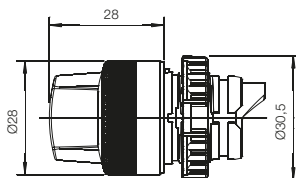

CKIM

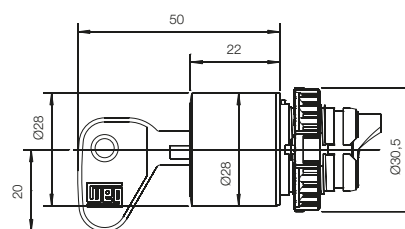

CYM

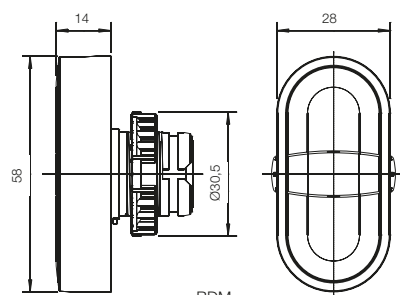

BDM

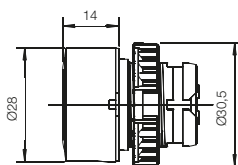

BFM

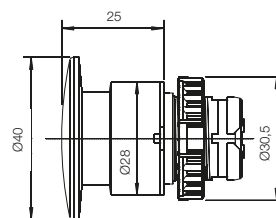

BCM

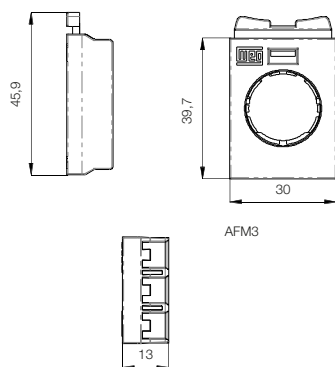

AFM3

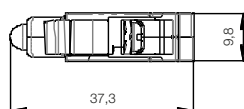

BIDLEF

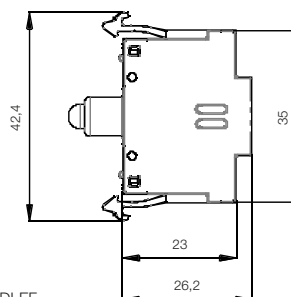

Dimensões (mm)

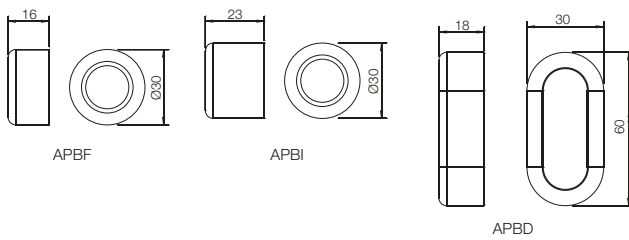
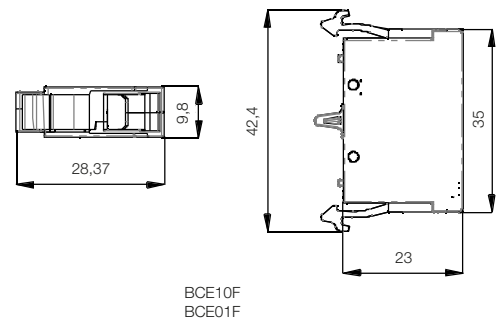
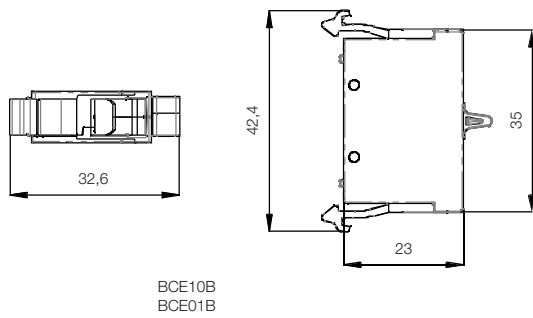
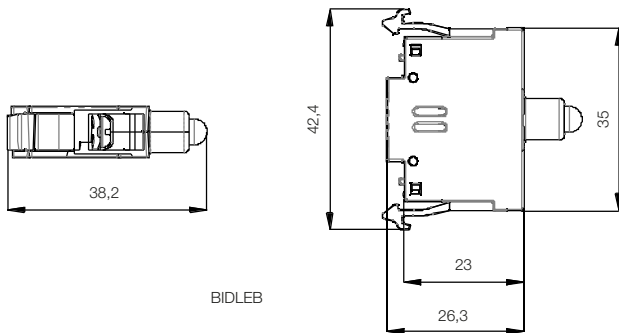

Dimensões (mm)

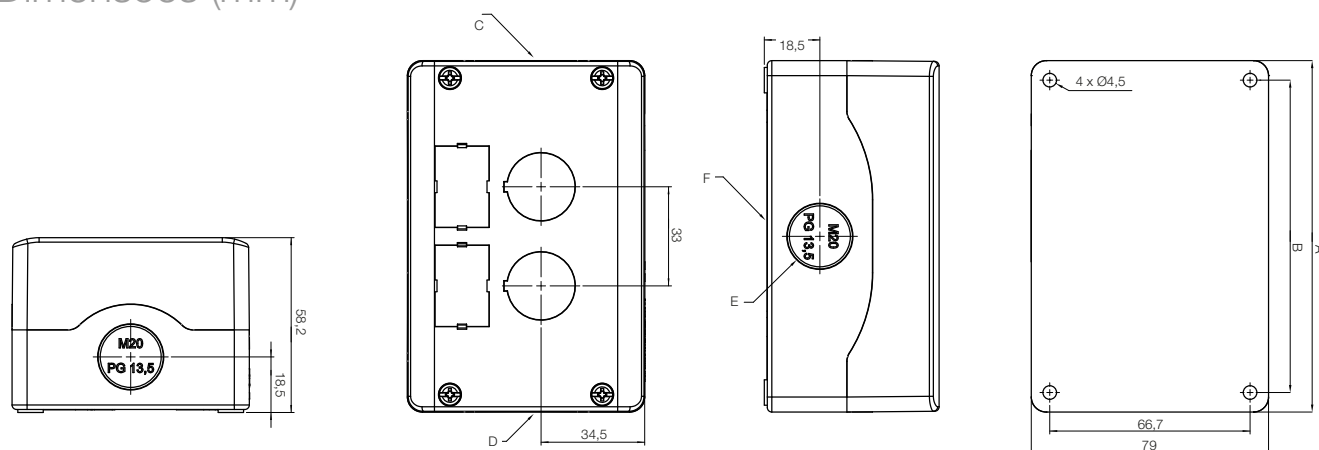

Caixas vazias PBWL

Número de furos	A	B	Entrada de prensa cabos			
			C (inferior)	D (superior)	E (lateral)	F (base)
1	74	66,7	1x ØM20/PG13,5	1x ØM20/PG13,5	1x ØM20/PG13,5	2x ØM16
2	117	104	1x ØM20/PG13,5	1x ØM20/PG13,5	1x ØM20/PG13,5	2x ØM16
3	150	137	1x ØM20/PG13,5	1x ØM20/PG13,5	2x ØM20/PG13,5	2x ØM16
4	183	170	1x ØM20/PG13,5	1x ØM20/PG13,5	2x ØM20/PG13,5	2x ØM16
6	249	236	1x ØM20/PG13,5	1x ØM20/PG13,5	2x ØM20/PG13,5	2x ØM16

Entrada para Rosca

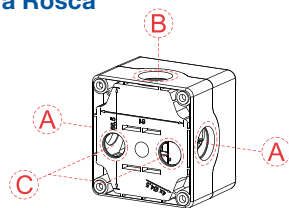

	A	B	C
PBWL-1 PBWL-1Y	2 x M20 PG13.5 1/2"	1 x M20 PG13.5 1/2"	2 x M16 "PG9"
PBWL-2			
PBWL-3		2 x M20 PG13.5 1/2"	
PBWL-4			
PBWL-6			

Distâncias de Instalação (mm)

Flange de 3 Posições AFM3

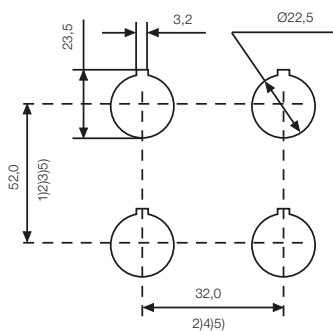

Caixas Plásticas PBWL

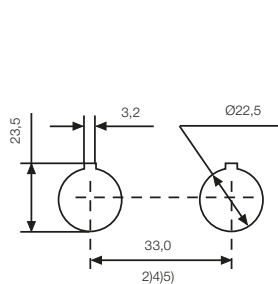

Presença Global é essencial. Entender o que você precisa também.

Presença Global

Com mais de 30.000 colaboradores por todo o mundo, somos um dos maiores produtores mundiais de motores elétricos, equipamentos e sistemas eletroeletrônicos. Estamos constantemente expandindo nosso portfólio de produtos e serviços com conhecimento especializado e de mercado. Criamos soluções integradas e customizadas que abrangem desde produtos inovadores até assistência pós-venda completa.

Com o *know-how* da WEG, a linha de **comando e sinalização CEW** é a escolha certa para sua aplicação e seu negócio, com segurança, proteção e confiabilidade.



Disponibilidade é possuir uma rede global de serviços



Parceria é criar soluções que atendam suas necessidades



Competitividade é unir tecnologia e inovação

Conheça

Produtos de alto desempenho e confiabilidade, para melhorar o seu processo produtivo.

Excelência é desenvolver soluções que aumentem a produtividade de nossos clientes, com uma linha completa para automação industrial.



Acesse: www.weg.net

 youtube.com/wegvideos



Grupo WEG - Unidade Automação
Jaraguá do Sul - SC - Brasil
Telefone: (47) 3276-4000
automacao@weg.net
www.weg.net
www.youtube.com/wegvideos
[@weg_wr](https://www.instagram.com/weg_wr)

